

For reference only. See data sheet for the detailed specifications.

Technical Specification

EIA WR	WR62
Frequency Range(GHz)	12.4 – 18.0
Attenuation(dB/m)	0.95 Max.
VSWR	1.20:1 Max.
Average Power(KW CW)	0.4
Max. Twist(deg/m)	436
Min. E-Bend Radius(mm)	54
Min. H-Bend Radius(mm)	105
Flange	FBP140(UBR140)
Jacket	Rubber
Operating Temp.(°C)	-55 ~ +85
Material	Cu
Length(mm)	1500
Net Weight(Kg)	0.61 Around



Outline Drawing (Size: mm)

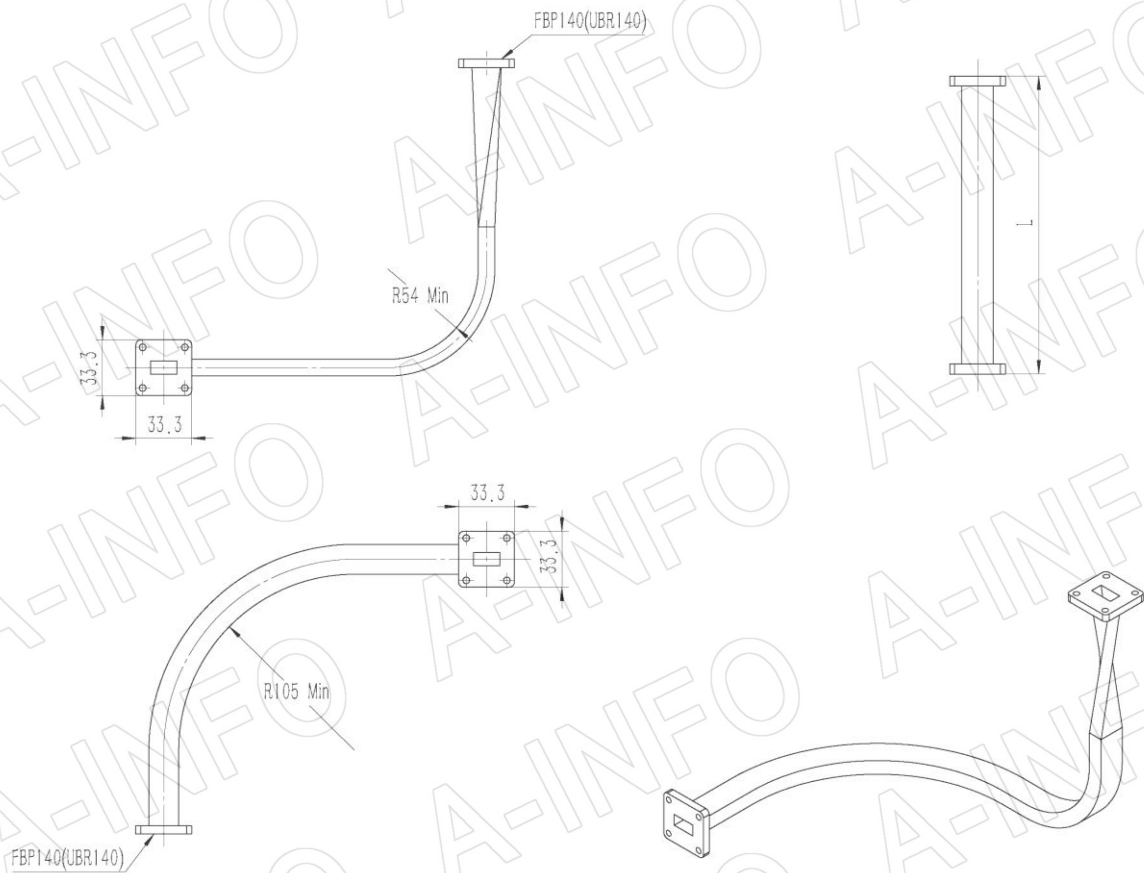

AINFO Inc.

Page 1 of 3

China(Beijing): Tel: (+86) 10-6266-7326,
 China(Chengdu): Tel: (+86) 28-8519-2786,
 USA: Tel: (+1) 949-639-9688,

(+86) 10-6266-7327 Fax: (+86) 10-6266-7379
 (+86) 28-8519-3044 Fax: (+86) 28-8519-3068
 (+1) 949-639-9608 Fax: (+1) 949-639-9670

Website: www.ainfoinc.com
 Email: sales@ainfoinc.com

Flange Drawing (Size: mm)

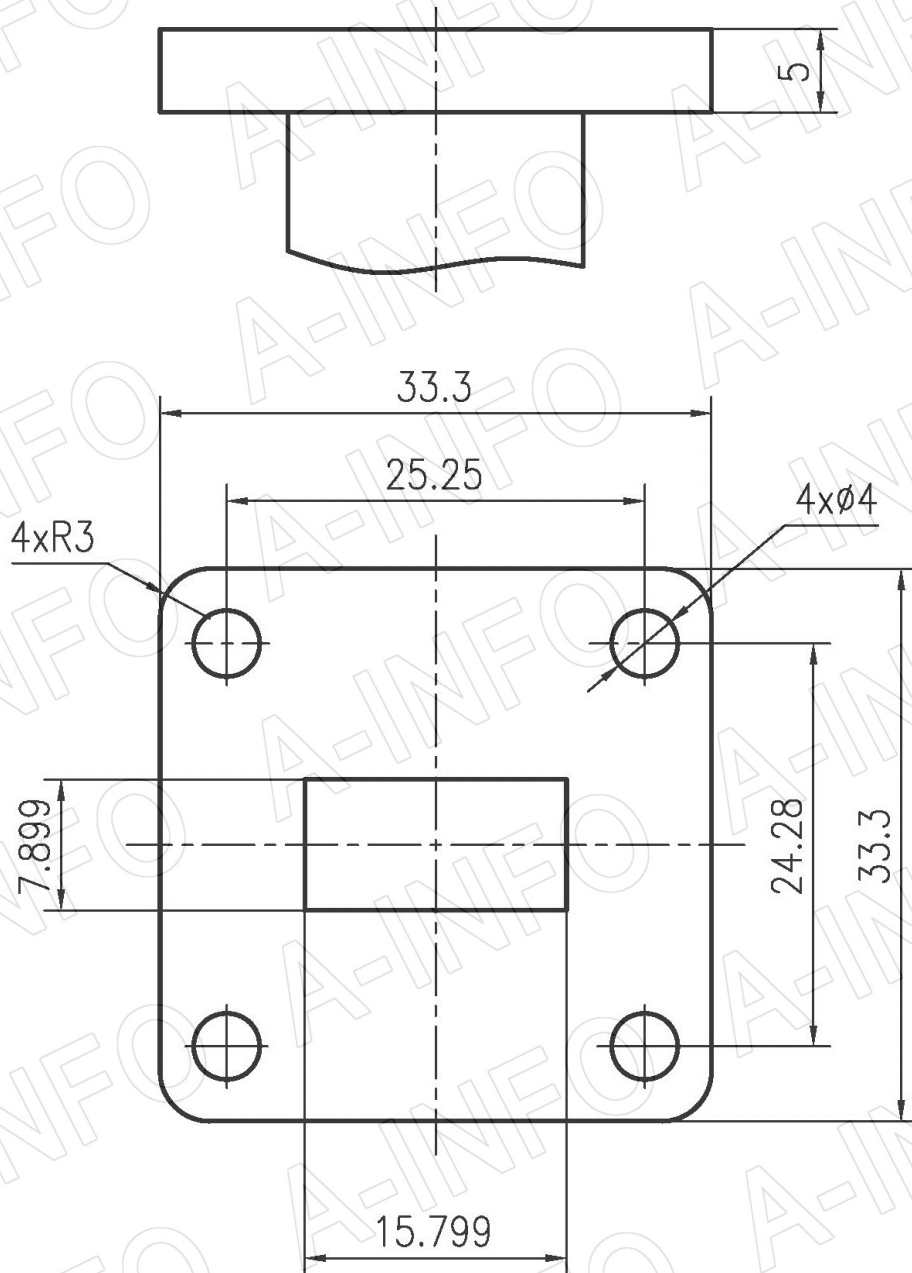

FBP140

AINFO Inc.

Page 2 of 3

China(Beijing): Tel: (+86) 10-6266-7326,
China(Chengdu): Tel: (+86) 28-8519-2786,
USA: Tel: (+1) 949-639-9688,

(+86) 10-6266-7327 Fax: (+86) 10-6266-7379
(+86) 28-8519-3044 Fax: (+86) 28-8519-3068
(+1) 949-639-9608 Fax: (+1) 949-639-9670

Website: www.ainfoinc.com
Email: sales@ainfoinc.com

Test Results

Attenuation (I.L.: 0.3560dB/m Max.)

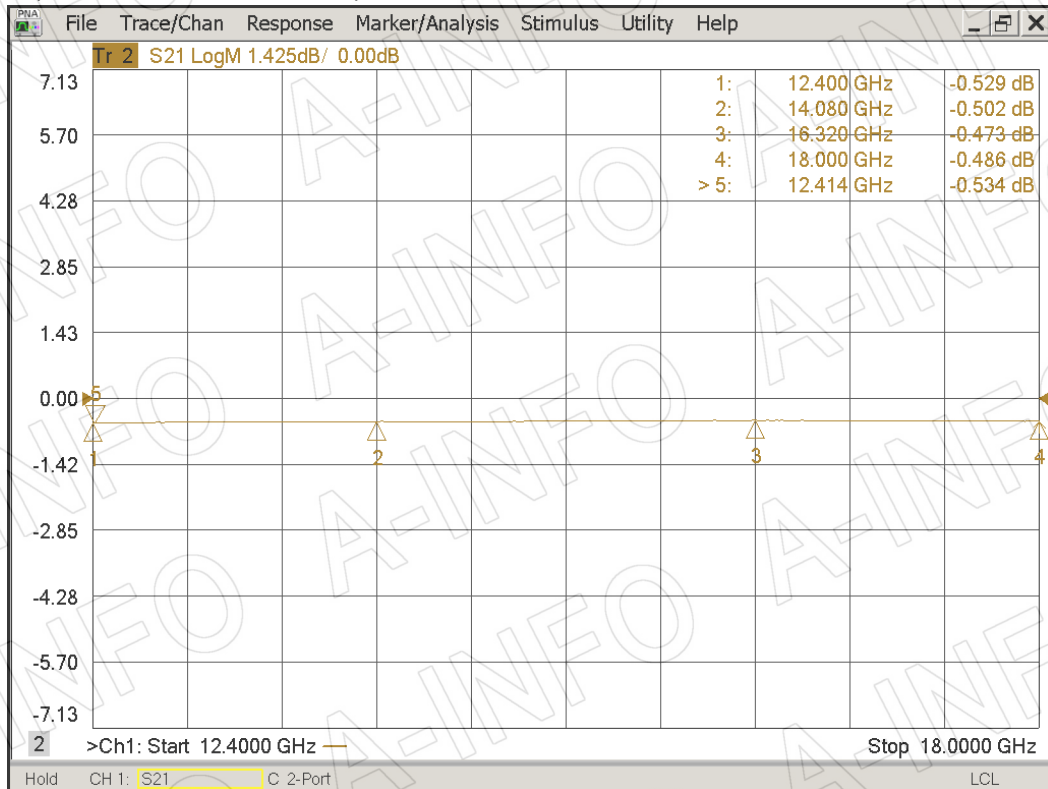

VSWR

